

# Virginia Pine

## Ground Floor

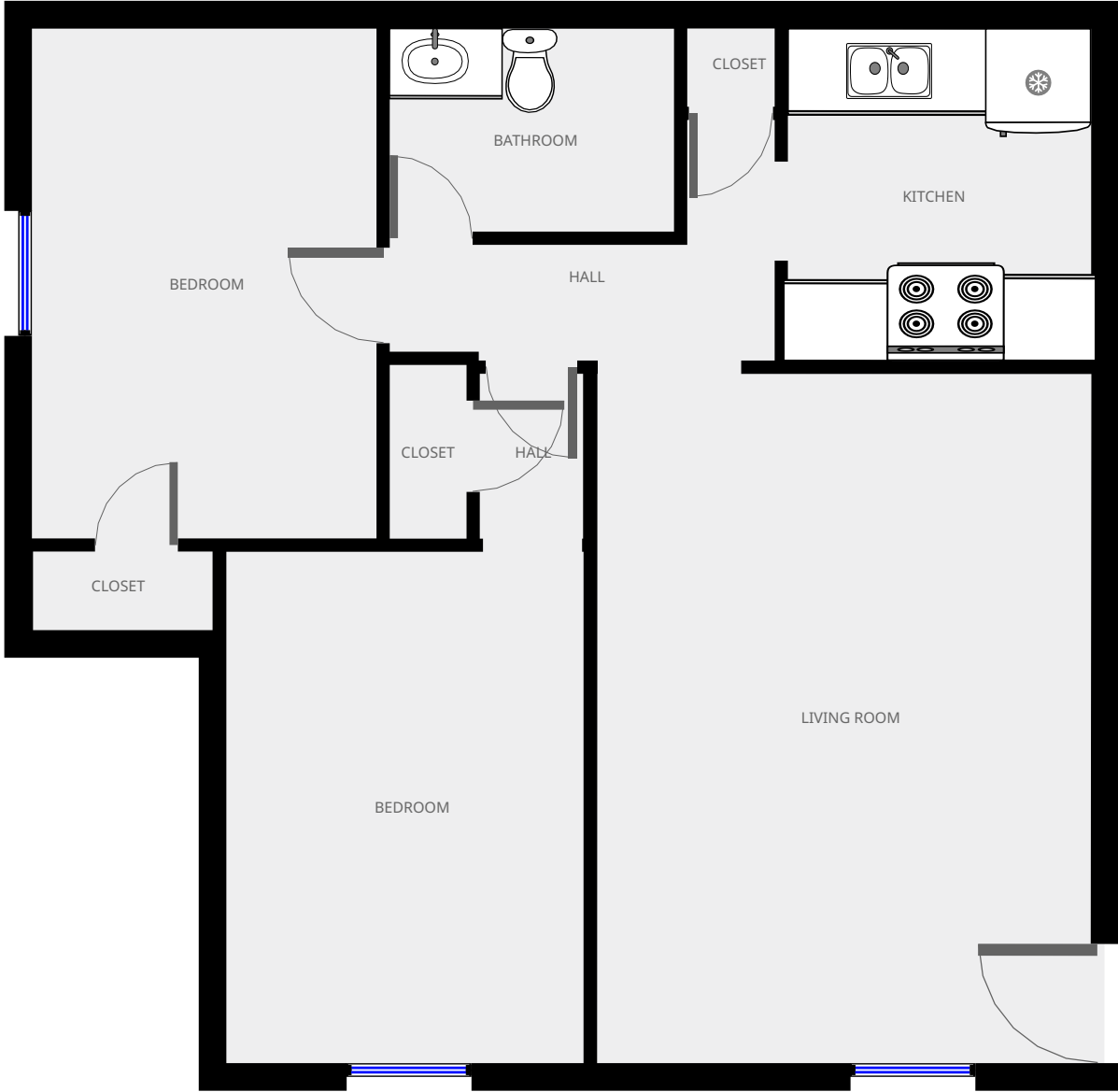

### Statistics

849 sq ft  
1 Floor  
2 Bedrooms  
1 Bathroom

THIS FLOORPLAN IS PROVIDED WITHOUT WARRANTY OF ANY KIND. SENSOPIA DISCLAIMS ANY WARRANTY INCLUDING, WITHOUT LIMITATION, SATISFACTORY QUALITY OR ACCURACY OF DIMENSIONS.



# Living Room

Width: 14' 7 3/4"  
 Length: 20' 5 3/4"  
 Area: 300.08 sq ft  
 Perimeter: 70' 3"  
 Ceiling Height: 7' 9 1/2"

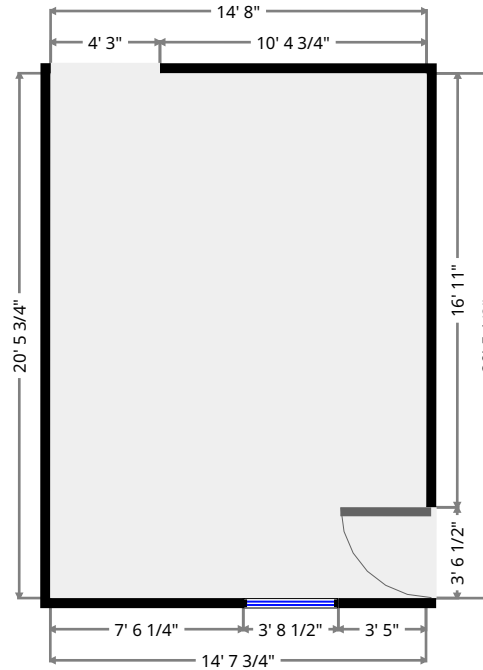
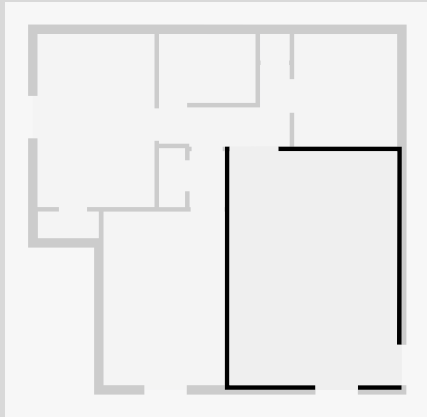

# Bedroom

Width: 10' 7 1/4"  
 Length: 15' 2 1/4"  
 Area: 161.08 sq ft  
 Perimeter: 51' 7"  
 Ceiling Height: 7' 9 1/2"

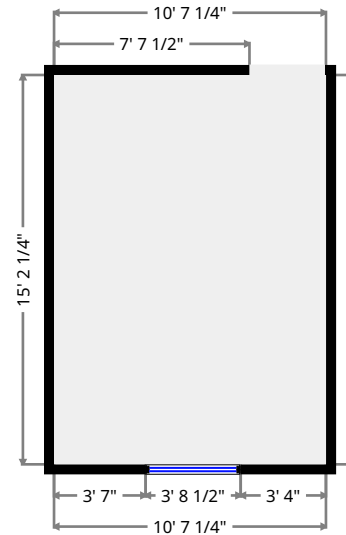
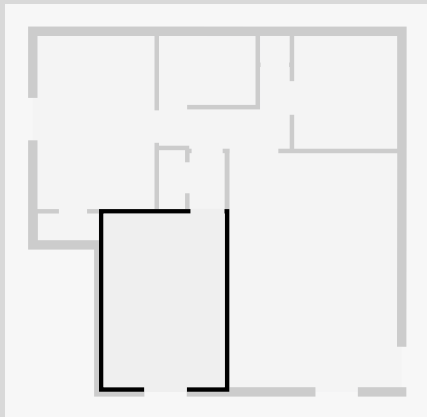

THIS FLOORPLAN IS PROVIDED WITHOUT WARRANTY OF ANY KIND. SENSOPIA DISCLAIMS ANY WARRANTY INCLUDING, WITHOUT LIMITATION, SATISFACTORY QUALITY OR ACCURACY OF DIMENSIONS.



## Hall

Width: 3' 3/4"  
 Length: 4' 10 3/4"  
 Area: 15.03 sq ft  
 Perimeter: 15' 11 1/4"

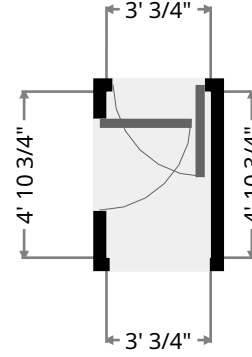
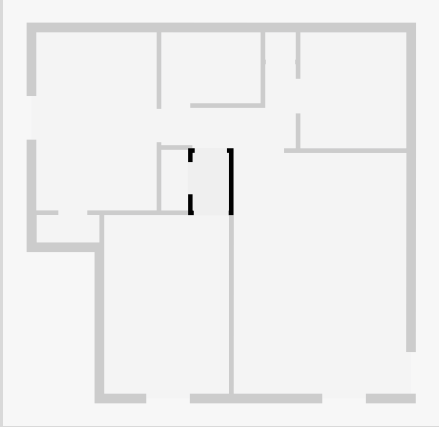

## Bedroom

Width: 10' 2 3/4"  
 Length: 15' 1 3/4"  
 Area: 154.90 sq ft  
 Perimeter: 50' 9"  
 Ceiling Height: 7' 9 1/2"

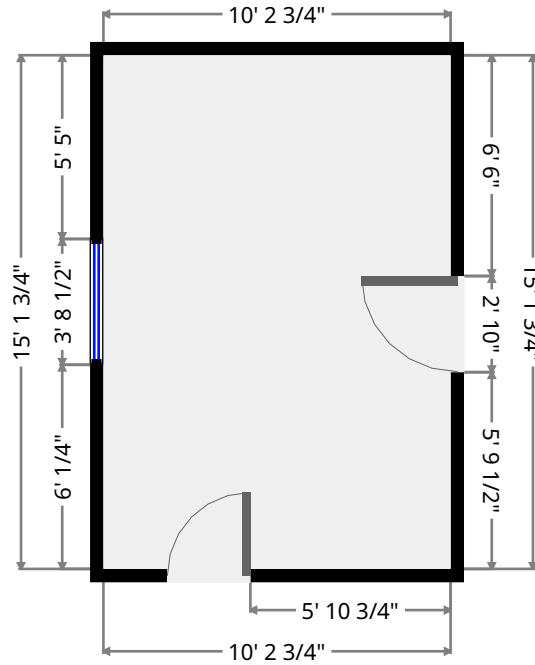
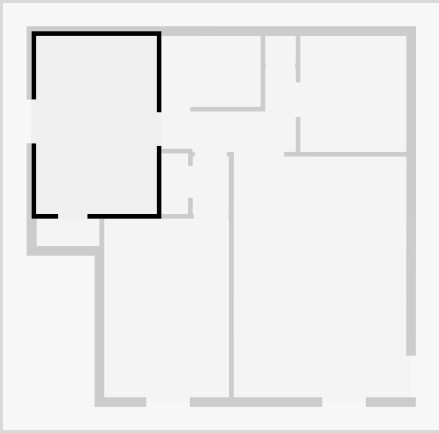

THIS FLOORPLAN IS PROVIDED WITHOUT WARRANTY OF ANY KIND. SENSOPIA DISCLAIMS ANY WARRANTY INCLUDING, WITHOUT LIMITATION, SATISFACTORY QUALITY OR ACCURACY OF DIMENSIONS.

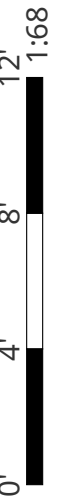

## Closet

Width: 2' 3 1/4"  
 Length: 5' 2"  
 Area: 11.75 sq ft  
 Perimeter: 14' 10 1/2"

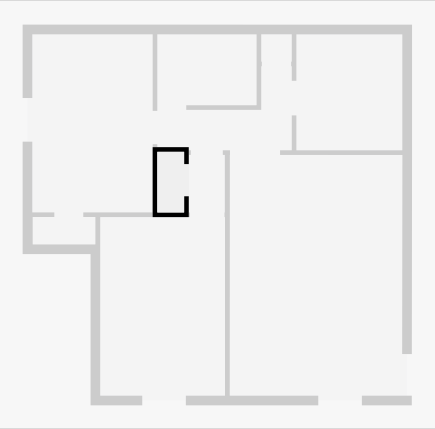

## Bathroom

Width: 6' 1/4"  
 Length: 8' 5 1/4"  
 Area: 50.86 sq ft  
 Perimeter: 28' 11 1/4"  
 Ceiling Height: 7' 9 1/2"

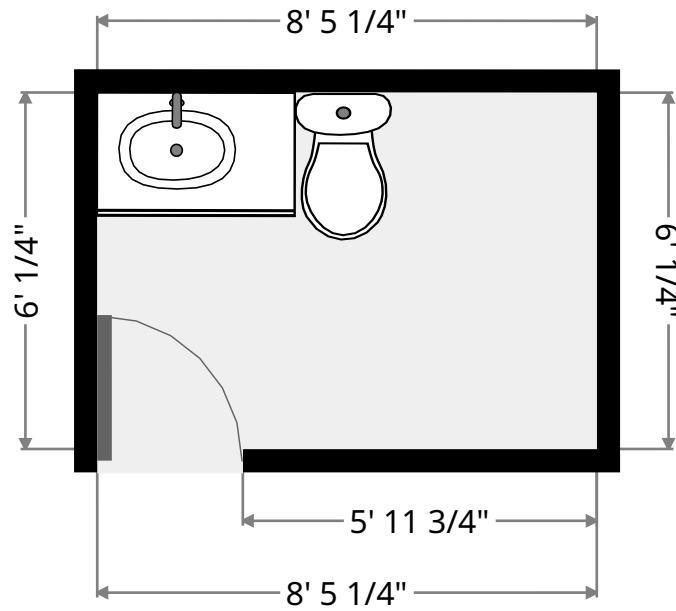
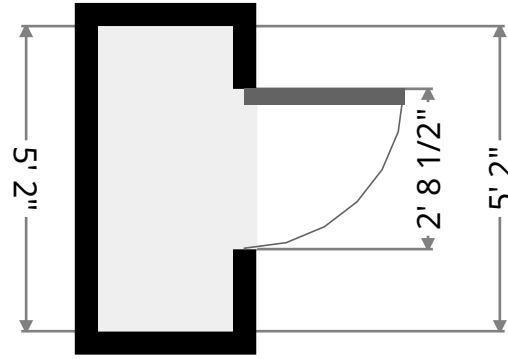
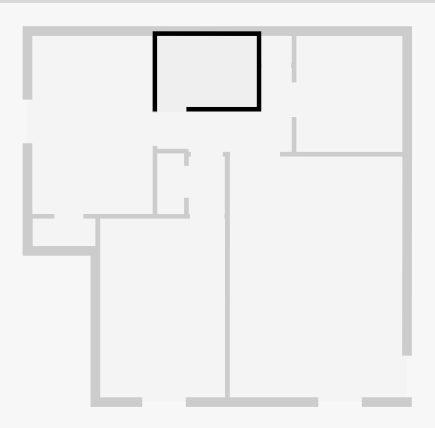

THIS FLOORPLAN IS PROVIDED WITHOUT WARRANTY OF ANY KIND. SENSOPIA DISCLAIMS ANY WARRANTY INCLUDING, WITHOUT LIMITATION, SATISFACTORY QUALITY OR ACCURACY OF DIMENSIONS.

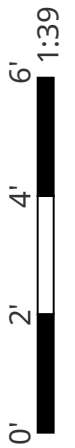

## Closet

Width: 2' 3 3/4"  
 Length: 2' 7 1/4"  
 Area: 6.03 sq ft  
 Perimeter: 9' 10"  
 Ceiling Height: 7' 9 1/2"

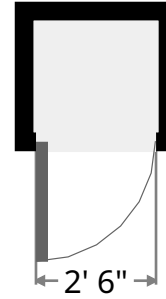
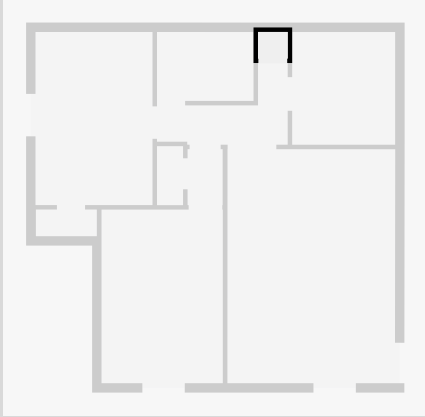

## Kitchen

Width: 9'  
 Length: 9' 10 1/4"  
 Area: 88.74 sq ft  
 Perimeter: 37' 8 3/4"  
 Ceiling Height: 7' 9 1/2"

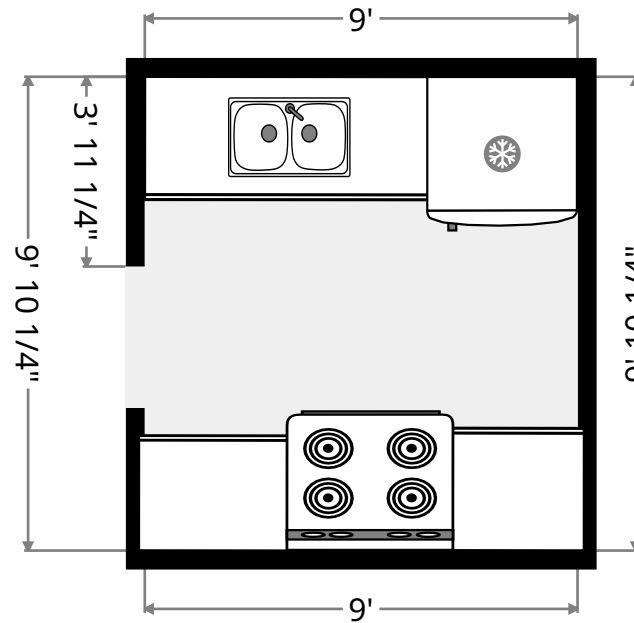
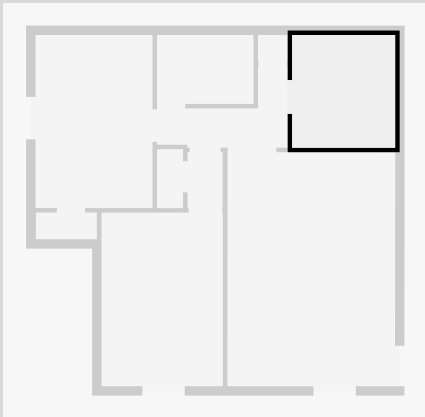

THIS FLOORPLAN IS PROVIDED WITHOUT WARRANTY OF ANY KIND. SENSOPIA DISCLAIMS ANY WARRANTY INCLUDING, WITHOUT LIMITATION, SATISFACTORY QUALITY OR ACCURACY OF DIMENSIONS.

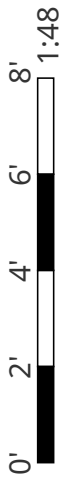

## Closet

Width: 2' 4"  
 Length: 5' 4"  
 Area: 12.42 sq ft  
 Perimeter: 15' 3 3/4"

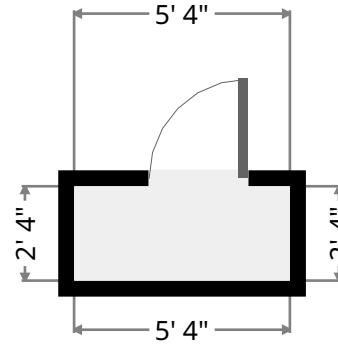
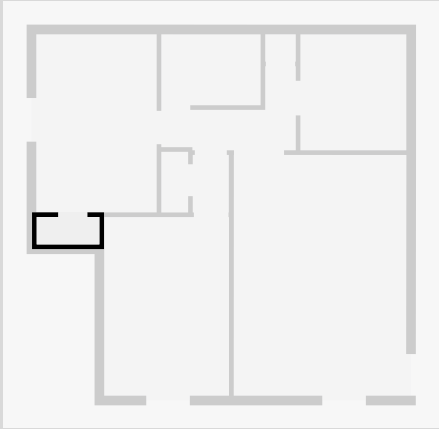

## Hall

Width: 7' 1 3/4"  
 Length: 11' 5 1/4"  
 Area: 48.20 sq ft  
 Perimeter: 37' 1 3/4"

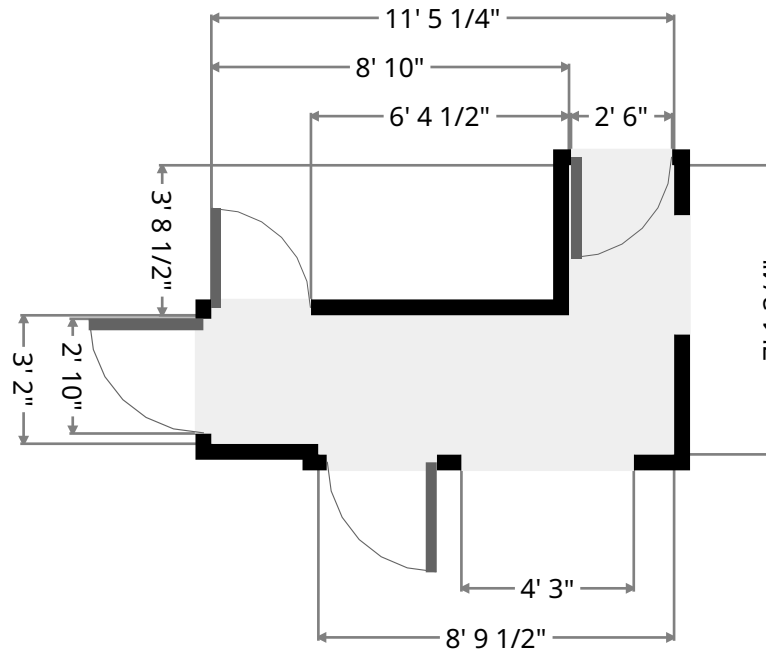
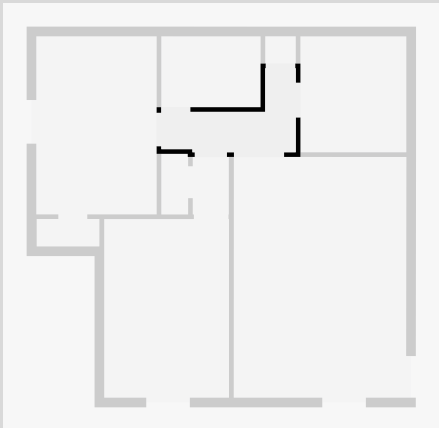

THIS FLOORPLAN IS PROVIDED WITHOUT WARRANTY OF ANY KIND. SENSOPIA DISCLAIMS ANY WARRANTY INCLUDING, WITHOUT LIMITATION, SATISFACTORY QUALITY OR ACCURACY OF DIMENSIONS.

