

Western Pine

Ground Floor

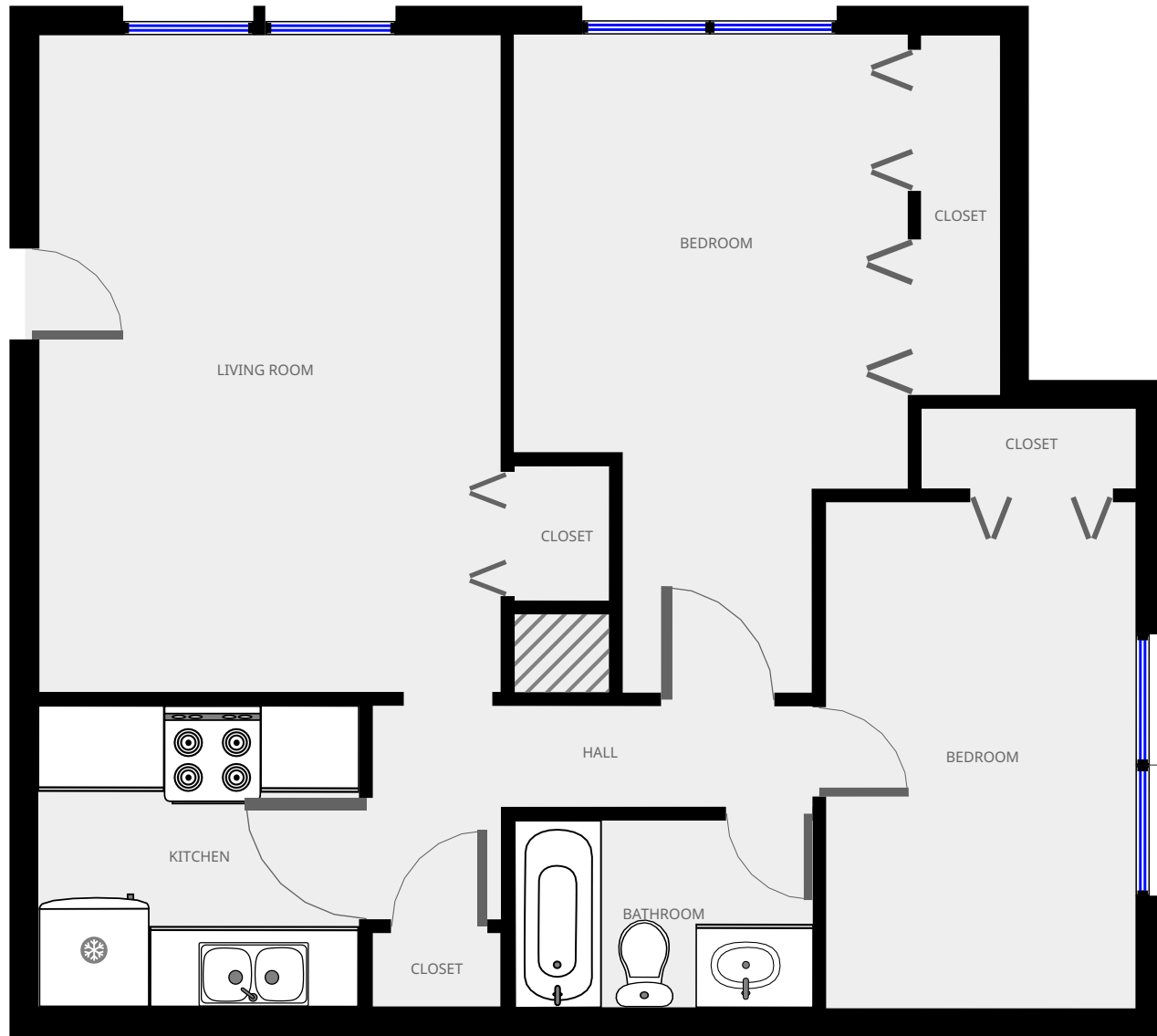

Statistics

772 sq ft
1 Floor
2 Bedrooms
1 Bathroom

THIS FLOORPLAN IS PROVIDED WITHOUT WARRANTY OF ANY KIND. SENSOPIA DISCLAIMS ANY WARRANTY INCLUDING, WITHOUT LIMITATION, SATISFACTORY QUALITY OR ACCURACY OF DIMENSIONS.



Living Room

Width: 13' 1 3/4"
 Length: 18' 8 1/2"
 Area: 246.03 sq ft
 Perimeter: 63' 8 3/4"
 Ceiling Height: 7' 9 1/2"

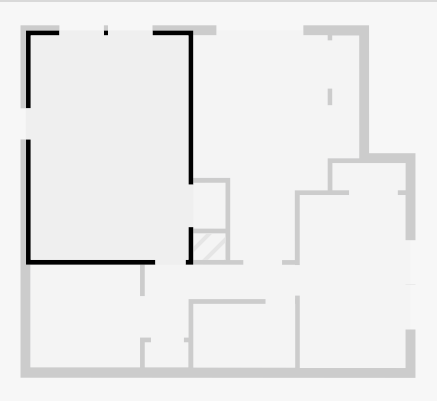

Closet

Width: 2' 8 1/4"
 Length: 3' 10"
 Area: 10.28 sq ft
 Perimeter: 13' 1/4"
 Ceiling Height: 7' 9 1/2"

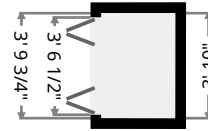
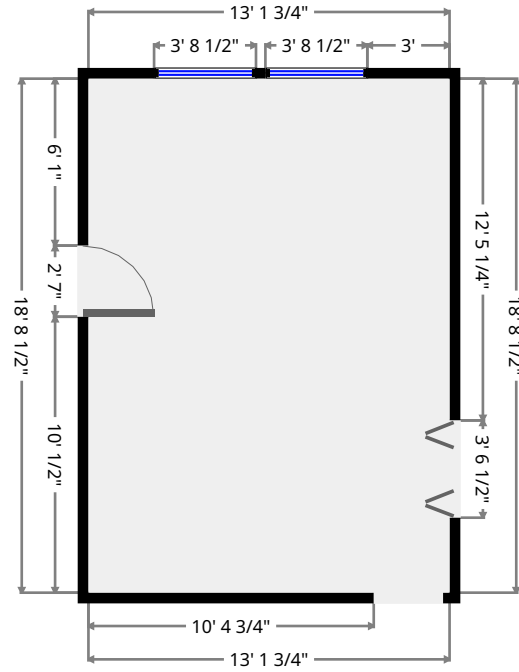
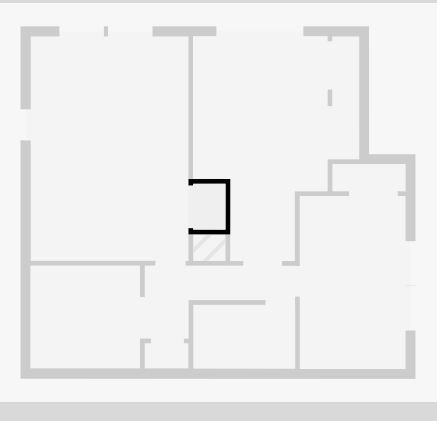

THIS FLOORPLAN IS PROVIDED WITHOUT WARRANTY OF ANY KIND. SENSOPRIA DISCLAIMS ANY WARRANTY INCLUDING, WITHOUT LIMITATION, SATISFACTORY QUALITY OR ACCURACY OF DIMENSIONS.



Bedroom

Width: 11' 2 3/4"
 Length: 18' 9"
 Area: 173.35 sq ft
 Perimeter: 59' 11 1/2"
 Ceiling Height: 7' 9 1/2"

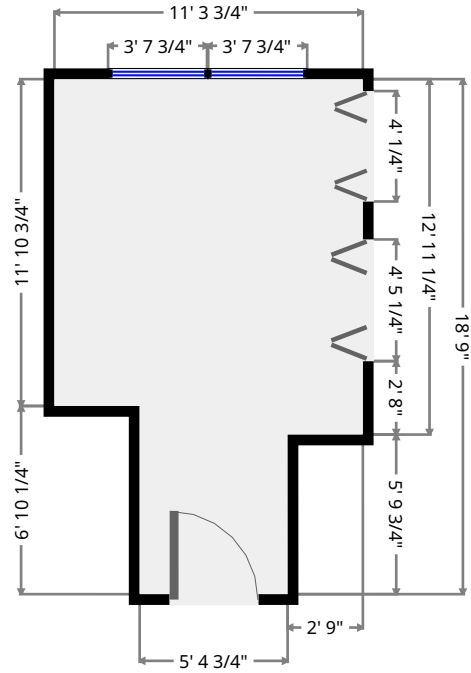
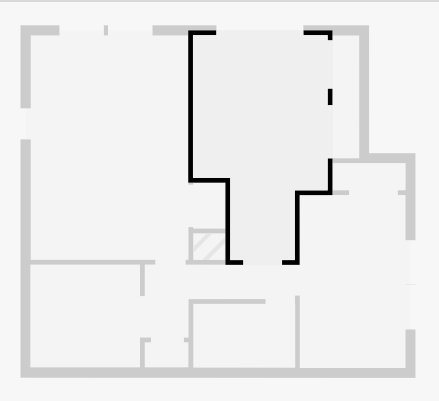

Closet

Width: 2' 3"
 Length: 10' 2 3/4"
 Area: 23.04 sq ft
 Perimeter: 24' 11 3/4"
 Ceiling Height: 7' 9 1/2"

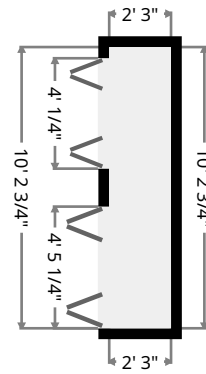
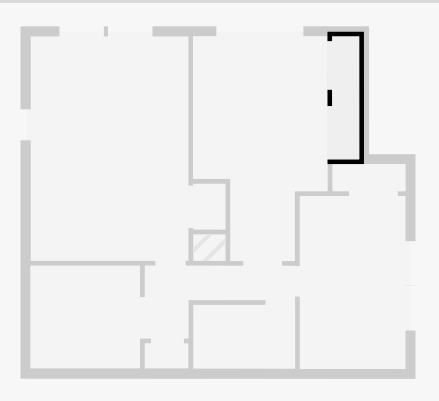

THIS FLOORPLAN IS PROVIDED WITHOUT WARRANTY OF ANY KIND. SENSOPIA DISCLAIMS ANY WARRANTY INCLUDING, WITHOUT LIMITATION, SATISFACTORY QUALITY OR ACCURACY OF DIMENSIONS.

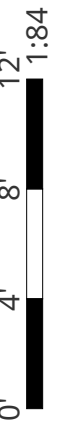

Kitchen

Width: 8' 6 3/4"
 Length: 9' 1 3/4"
 Area: 78.34 sq ft
 Perimeter: 35' 5"
 Ceiling Height: 7' 9 1/2"

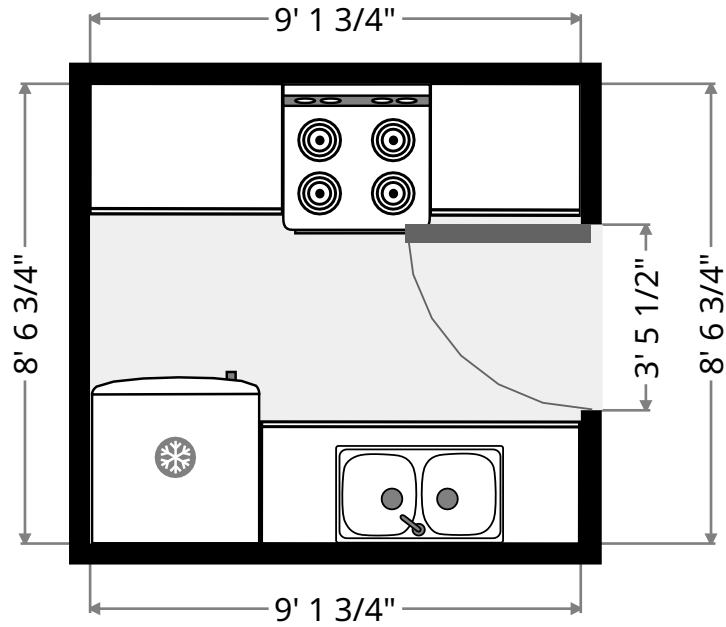
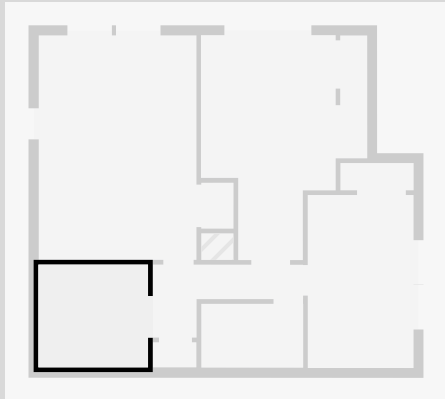

Closet

Width: 2' 1"
 Length: 3' 7 3/4"
 Area: 7.59 sq ft
 Perimeter: 11' 5 1/2"
 Ceiling Height: 7' 9 1/2"

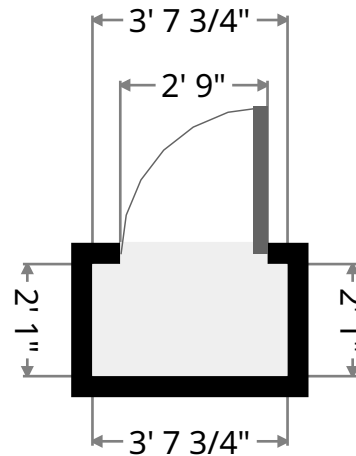
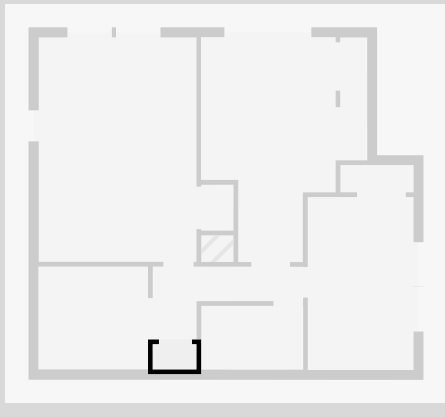

THIS FLOORPLAN IS PROVIDED WITHOUT WARRANTY OF ANY KIND. SENSOPRIA DISCLAIMS ANY WARRANTY INCLUDING, WITHOUT LIMITATION, SATISFACTORY QUALITY OR ACCURACY OF DIMENSIONS.



Bathroom

Width: 5' 3 3/4"
 Length: 8' 6"
 Area: 45.18 sq ft
 Perimeter: 27' 7 1/2"
 Ceiling Height: 7' 9 1/2"

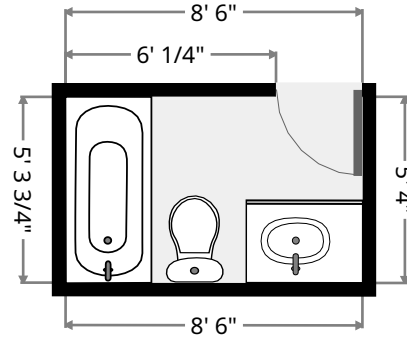
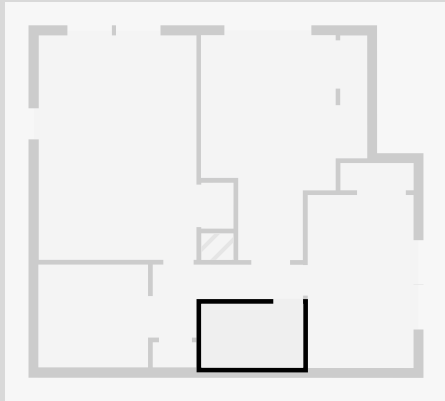

Bedroom

Width: 8' 9 3/4"
 Length: 14' 5"
 Area: 127.10 sq ft
 Perimeter: 46' 5 1/2"
 Ceiling Height: 7' 9 1/2"

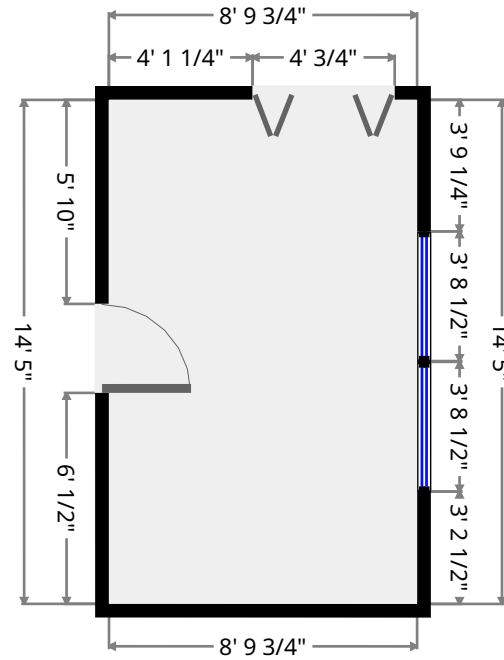
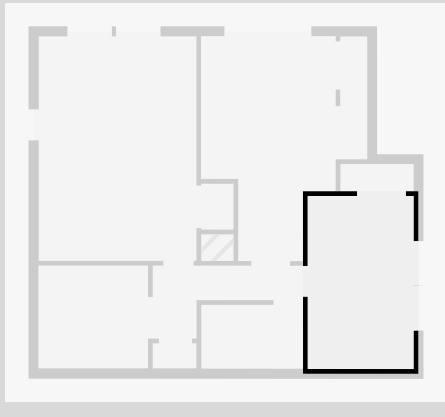

THIS FLOORPLAN IS PROVIDED WITHOUT WARRANTY OF ANY KIND. SENSOPIA DISCLAIMS ANY WARRANTY INCLUDING, WITHOUT LIMITATION, SATISFACTORY QUALITY OR ACCURACY OF DIMENSIONS.

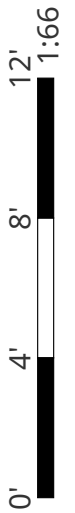

Closet

Width: 2' 3 1/4"
 Length: 6' 1 1/4"
 Area: 13.88 sq ft
 Perimeter: 16' 9"

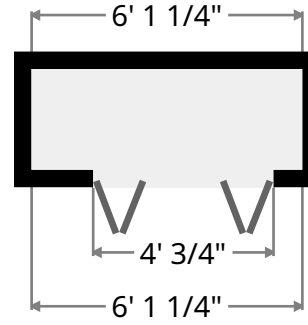
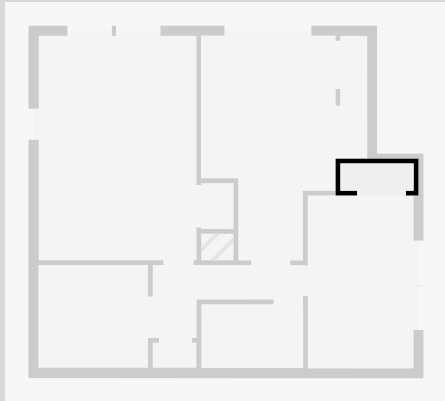

Hall

Width: 6' 1"
 Length: 12' 6 1/4"
 Area: 47.67 sq ft
 Perimeter: 37' 2 1/2"

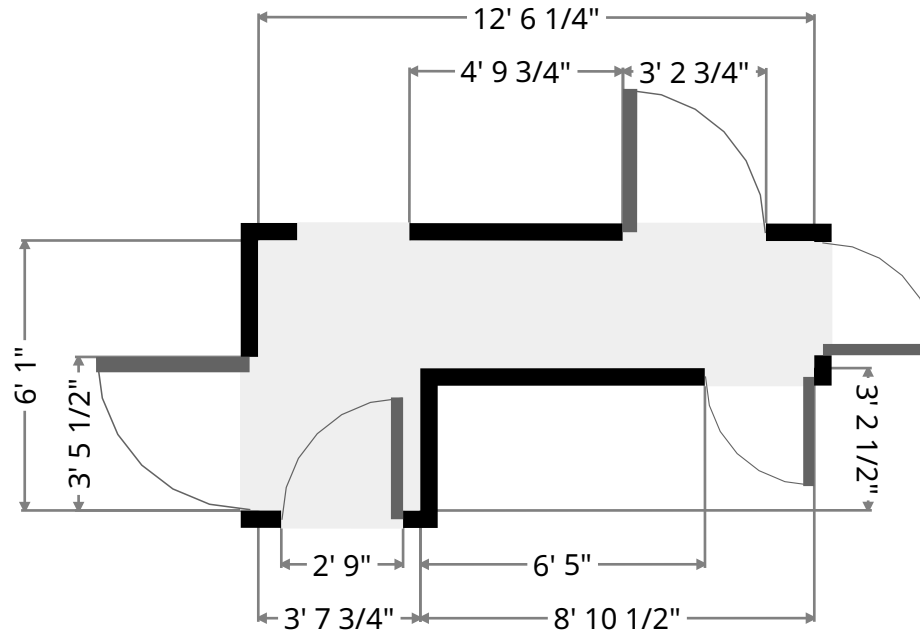
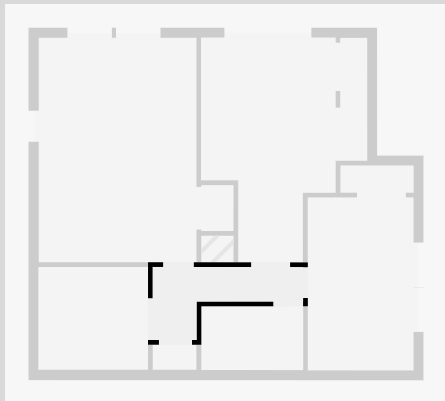

THIS FLOORPLAN IS PROVIDED WITHOUT WARRANTY OF ANY KIND. SENSOPIA DISCLAIMS ANY WARRANTY INCLUDING, WITHOUT LIMITATION, SATISFACTORY QUALITY OR ACCURACY OF DIMENSIONS.

